



PALISADE™

Waterproof, Grout-Free Wall Tiles

- Waterproof, lightweight, rigid PVC
- Scratch- and UV-resistant
- Fast and easy installation, no grout required
- Unique interlocking edges look like grout lines
- Glues onto almost any surface
- Easy to clean & maintain
- 10-year warranty



Frost Nickel

PALISADE

Waterproof, Grout-Free Wall Tiles

Palisade waterproof, grout-free wall tiles and planks have unique interlocking joints and can be cut to size for an easy, groutless installation. This versatile, low-maintenance tile is perfect for wet areas like showers and bathrooms or for commercial high-traffic areas in multi-family units, hotels, restaurants and hospitals.

Surface Burning Characteristics	ASTM E 84 Class "B" fire-rated – Flame
Durability	Waterproof, mold- and mildew-resistant
Material	Virgin-grade rigid PVC
Compatibility	Wall panels install as a glue-up application with recommended adhesive
Warranty	10-year limited warranty

Durable, Engineered Composition

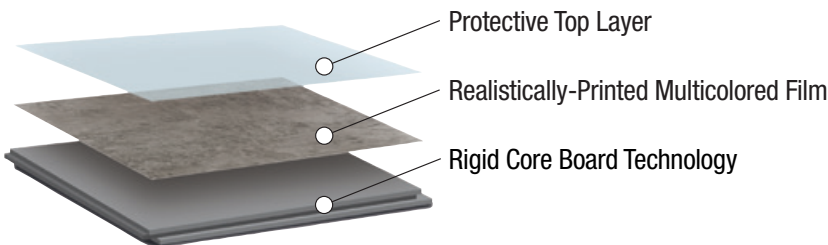

Size Options

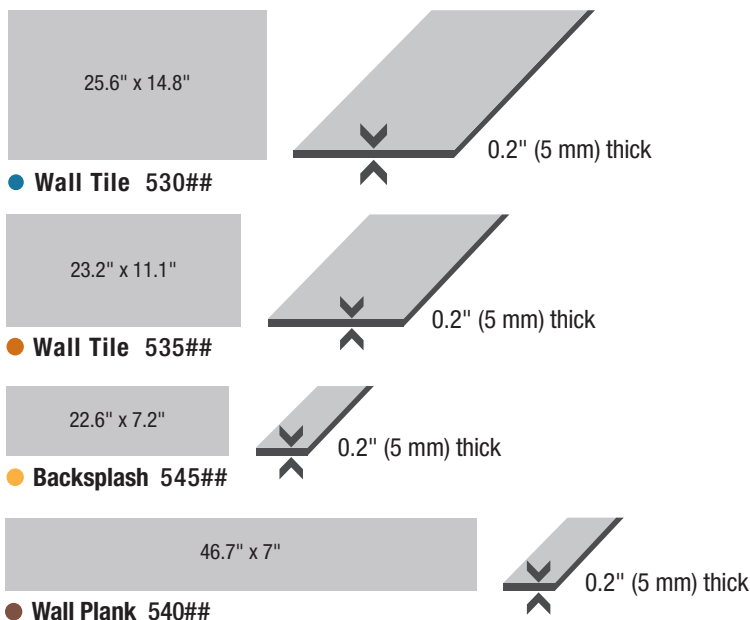

Interlocking edges require no grout



Glues onto almost any surface



Lock tiles by sliding into joint

For wet environments, use a silicone-based sealant in seams.

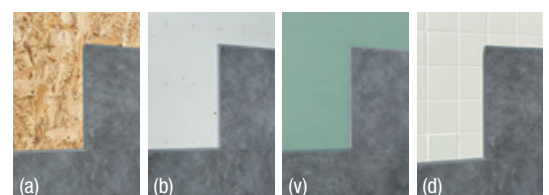

Palisade can be installed over many substrates including (a) OSB/plywood, (b) drywall, (c) water-resistant board and (d) ceramic tile



Oak Mocha



Carrara Marble



Spanish Marble



Iced Pewter



Cracked Slate



Ashen Slate

Matching Accessories

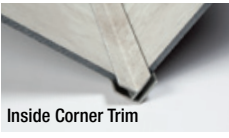

Inside Corner Trim

Inside Corner Trim, J-Trim and L-Trim add a finished look to exposed tiles, edges and corners. Use adhesive to affix and finish with sealant.



J-Trim

173## Trim Kit – 94"
(Kits include 2 Inside Corner Trims, 2 J-Trims & 2 L-Trims)



Inside Corner Trim

189## Inside Corner Trim – 94" (5 pack)
190## J-Trim – 94" (5 pack)
191## L-Trim – 94" (5 pack)

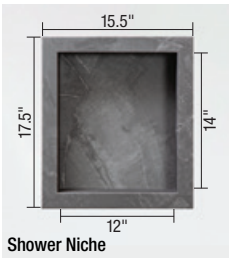

Shower Niche

Matching shower shelves and niches add practical storage space to shower installations.

536 ## Shower Niche – (1 pack)
Perimeter: 17.5" x 15.5" x 3.75"
Opening: 14" x 12" x 3.5"



Shower Shelf

537## Shower Shelf – (1 pack)
14.56" x 7.12" x 2"

= finish number



Venetian Marble

Finishes

- | | | |
|----------------------|--------------------|----------------|
| 00 Ashen Slate | 10 Carrara Marble | 20 Polar Frost |
| 01 Grecian Earth | 11 Venetian Marble | 80 Gray Oak |
| 02 Frost Nickel | 12 Dusty Pearl | 81 Natural Oak |
| 03 Louvre Granite | 13 Woven Heather | 82 Oak Mocha |
| 04 Hermitage Granite | 14 Silver Lake | |
| 05 Prado Granite | 15 Smoky Sky | |
| 06 Wind Gust | 16 Iced Pewter | |
| 07 Rain Cloud | 17 Black Ice | |
| 08 Wintry Mix | 18 Cracked Slate | |
| 09 Adobe Drift | 19 Spanish Marble | |

Finishes

See color coding below for size options and availability.



Ashen Slate 00 ●●●



Grecian Earth* 01 ●●●



Frost Nickel 02 ●●●



Louvre Granite* 03 ●●●

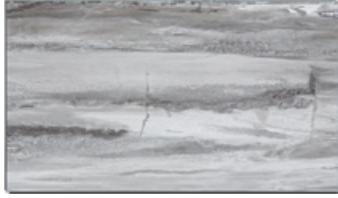

Hermitage Granite* 04 ●●●

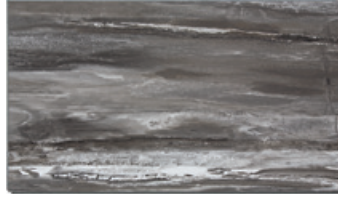

Prado Granite* 05 ●●●



Wind Gust 06 ●●●



Rain Cloud* 07 ●

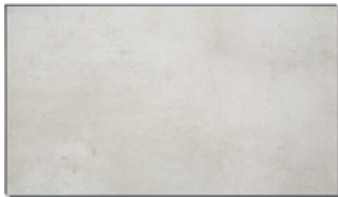

Wintry Mix 08 ●●●



Adobe Drift* 09 ●●●



Carrara Marble 10 ●●●



Venetian Marble 11 ●●●

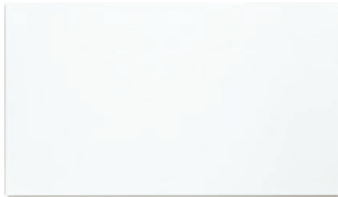

Dusty Pearl 12 ●



Woven Heather 13 ●



Silver Lake 14 ●



Smoky Sky 15 ●



Iced Pewter 16 ●



Black Ice 17 ●●

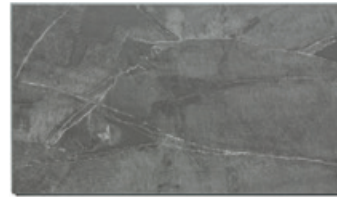

Cracked Slate 18 ●

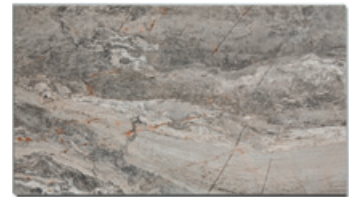

Spanish Marble 19 ●



Polar Frost 20 ●



Gray Oak 80 ●



Natural Oak 81 ●



Oak Mocha 82 ●

Size Options



● Wall Tile 530##
21 sq ft per box

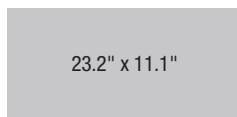

● Wall Tile 535##
17.9 sq ft per box

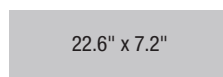

● Backsplash 545##
11 sq ft per box

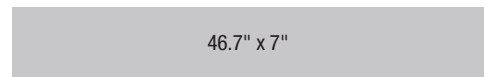

● Wall Plank 540##
16.3 sq ft per box

= finish number * = inquire for latest availability details

For more information or to place an order, please call 800-434-3750 or email sales@acpideas.com. Visit us online at palisade-tiles.com